



SKYTECH
PRODUCTS GROUP

Model: TM/R-AF1-1 INSTALLATION AND OPERATING INSTRUCTIONS

**SINGLE-FUNCTION WIRELESS REMOTE CONTROL SYSTEM
FOR OPERATING VALVES WITH ON/OFF LATCHING SOLENOIDS**

**IF YOU CANNOT READ OR UNDERSTAND THESE INSTALLATION INSTRUCTIONS DO NOT
ATTEMPT TO INSTALL OR OPERATE**

INTRODUCTION

This SKYTECH remote Wireless Wall Timer system was developed to provide safe, reliable, and user-friendly remote control system for gas heating appliances. The system can be operated manually from the transmitter. The system operates on one of 65,536 security codes that are programmed into the transmitter at the factory.

WALL TIMER

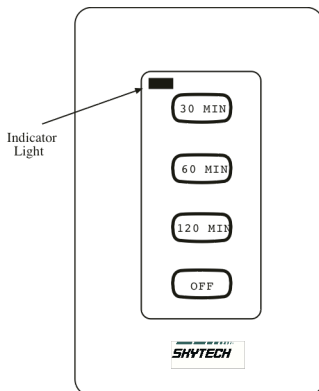

The wall timer operates on a (2) 3V button cell batteries (included) made specifically for remote controls and electronic lighters. Before using the wall transmitter, install the two (2) 3V button cell batteries. Follow instructions below.

The wall timer has a 30 min, 60 min, 120 min, and OFF buttons. When any of the buttons on the wall timer is pressed, a signal light on the wall timer illuminates briefly to verify that a signal has been sent. If the signal light does not illuminate, check the batteries. Upon initial use, there may be a delay of 5-seconds before the remote receiver will respond to the wall timer.

TO INSTALL BATTERIES

1. Remove face from backing plate by insetting a small screwdriver into the small slot at the top or bottom of the faceplate as shown below then snap OFF.
2. Locate the (2) holders for the 3V button cell batteries.
3. Place the button cell batteries into the battery holders and snap into place. (Make sure that the batteries are installed with the (+) plus side as shown to the right.
4. After the batteries are installed replace the faceplate on the base.

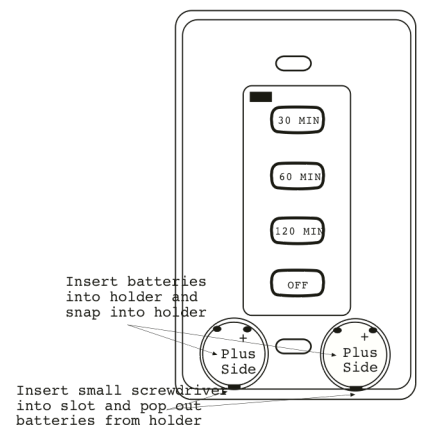

TO REMOVE THE BATTERIES

1. Remove face from backing plate by insetting a small screwdriver into the small slot on the side at the top or bottom of the faceplate as shown to the right then snap OFF.
2. Locate the (2) holders for the 3V button cell batteries.
3. Insert a small screwdriver into the slot at the button cell battery and pop the battery out (Slots shown in picture above).
4. After the batteries are installed replace the faceplate.

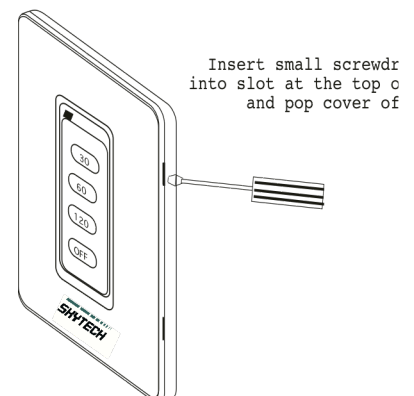

WALL MOUNTING THE TIMER

1. Remove face from backing plate by inserting a small screwdriver into the small slot at the top or bottom of the faceplate as shown to the right then snap OFF.
2. Locate the (2) two mounting holes and mark the holes on the wall.
3. Use the (2) two dry wall anchors and screws (that are supplied) to mount the base plate to the wall as shown.
4. The wall transmitter can also be mounted onto an existing (Plastic) electrical box.
5. Base plate should be mounted level on the wall for best operation.

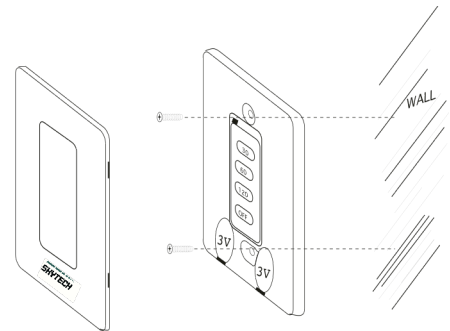

REMOTE RECEIVER

IMPORTANT

THE REMOTE RECEIVER SHOULD BE POSITIONED WHERE AMBIENT TEMPERATURES DO NOT EXCEED 130° F.

The remote receiver (right) operates on (4) 1.5-volt AA batteries. It is recommended that ALKALINE batteries be used for longer battery life and maximum microprocessor performance. **IMPORTANT:** New or fully charged batteries are essential to proper operation of the remote receiver as a latching solenoid power consumption is substantially higher than standard remote control systems.

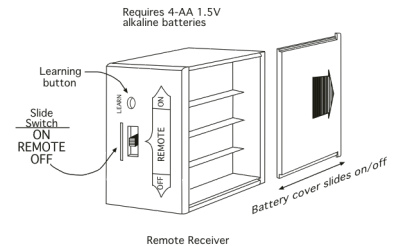

NOTE: The remote receiver will only respond to the transmitter when the 3-position slide button on the remote receiver is in the REMOTE position. The remote receiver houses the microprocessor that responds to commands from the transmitter to control system operation.

FUNCTIONS:

1. **With the slide switch in the REMOTE position, the system will only operate if the remote receiver receives commands from the transmitter.** Upon initial use or after an extended period of no use, the ON button may have to be pressed for up to three seconds before activating solenoid. If the system does not respond to the transmitter on initial use, see LEARNING TRANSMITTER TO RECEIVER section.
2. **Slide switch to ON for manual operation.**
3. **With the slide in the OFF position, the system is OFF.**
4. **It is suggested that the slide switch be placed in the OFF position if you will be away from your home for an extended period of time.** Placing the slide switch in the OFF position also functions as a safety "lock out" by both turning the system OFF and rendering the transmitter inoperative.

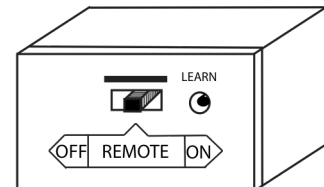

INSTALLATION INSTRUCTIONS

WARNING

DO NOT CONNECT REMOTE RECEIVER DIRECTLY TO 110-120VAC POWER. THIS WILL BURN OUT THE RECEIVER. FOLLOW INSTRUCTIONS FROM MANUFACTURER OF GAS VALVE FOR CORRECT WIRING PROCEDURES. IMPROPER INSTALLATION OF ELECTRIC COMPONENTS CAN CAUSE DAMAGE TO GAS VALVE AND REMOTE RECEIVER.

INSTALLATION

The remote receiver can be mounted on or near the fireplace hearth. **PROTECTION FROM EXTREME HEAT IS VERY IMPORTANT.** Like any piece of electronic equipment, the remote receiver should be kept away from temperatures exceeding 130° F inside the receiver case. Battery life is also significantly shortened if batteries are exposed to high temperatures.

Make sure the remote receiver switch is in the OFF position. For best results it is recommended that 18 gauge stranded wires should be used to make connections and no longer than 20-feet.

WIRING INSTRUCTIONS

CONNECTING THE RECEIVER TO A VALVE WITH THE LATCHING SOLENOID

1. Connect the BLACK 18 gage stranded wire with the 1/4' female terminal from the receiver to the BLACK wire with the 1/4" male terminals from the valve solenoid.
2. Connect the RED 18 gage stranded wire with the 1/4' female terminal from the receiver to the RED wire with the 1/4" male terminals from the valve solenoid.
3. After receiver wires are connected to the valve solenoid wire make sure the receiver shield is located over the receiver and then locate the receiver in an area that will not exceed the 130° F.

IMPORTANT NOTE: Operation of these controls is dependent on which wire is attached to which terminal. If operation of control does not correspond to operating buttons on transmitter, reverse wire installation at the receiver or at the control.

NOTE: Up to 6.3 VDC of power is provided at the receiver terminal.

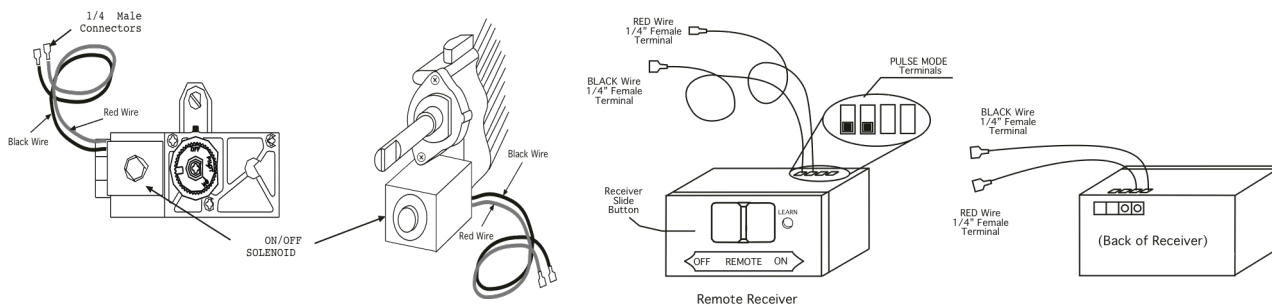

GENERAL INFORMATION

LEARNING TRANSMITTER TO RECEIVER

Each transmitter uses a unique security code. It will be necessary to press the LEARN button on the receiver to accept the transmitter security code upon initial use, if batteries are replaced, or if a replacement transmitter is purchased from your dealer or the factory. In order for the receiver to accept the transmitter security code, be sure the slide button on the receiver is in the REMOTE position; the receiver will **not** LEARN if the slide switch is in the ON or OFF position. The LEARN button is located on the front face of the receiver; inside the small hole labeled LEARN. Using a small screwdriver or end of a paperclip gently **Press and Release** the black LEARN button inside the hole. When you release the LEARN button the receiver will emit an audible "beep". After the receiver emits the beep press ANY transmitter button and release. The receiver will emit several beeps indicating that the transmitter's code has been accepted into the receiver.

The microprocessor that controls the security code matching procedure is controlled by a timing function. If you are unsuccessful in matching the security code on the first attempt, wait 1 - 2 minutes before trying again--this delay allows the microprocessor to reset its timer circuitry--and try up to two or three more times.

OPERATION

4. This remote control will operate the gas valves latching solenoid to open the gas flow to full ON.
5. When the ON button is depressed the transmitter sends a RF signal to the receiver. The receiver then sends a pulse of 6-volts of power to the solenoid. The solenoid then opens the gas flow to the burner then to full ON.
6. When the OFF button is depressed the transmitter sends a RF signal to the receiver. The receiver then sends a pulse of 6-volts of power to the solenoid. The solenoid then closes the gas flow to the burner then to full OFF.
7. The remote control will only work with the hand held transmitter. The receiver slide switch is only for positive OFF or REMOTE operation.

NOTE: Extensive use of the Latching Solenoid (ON/OFF) will reduce the receiver's battery life significantly.

BATTERY LIFE

Life expectancy of the alkaline batteries in the TM/R-AF1 can be up to 12 months depending on use of the solenoid function. Replace all batteries annually. When the transmitter no longer operates the remote receiver from a distance it did previously (i.e., the transmitter's range has decreased) or the remote receiver does not function at all, the batteries should be checked. It is important that the remote receiver batteries are fully charged, providing combined output voltage of at least 5.0 volts. The transmitter should operate with as little as 2.4 volts battery power. **NOTE:** Extensive use of the Solenoid will reduce the receiver's battery life significantly.

TROUBLE SHOOTING

If you encounter problems with your fireplace system, the problem may be with the fireplace itself or it could be with the TM/R-AF1 remote system. Review the fireplace manufacturer's operation manual to make sure all connections are properly made. Then check the operation of the remote in the following manner:

1. Make sure the batteries are correctly installed in the RECEIVER. One reversed battery will keep receiver from operating properly.
2. Check battery in TRANSMITTER to ensure contacts are touching (+) and (-) ends of battery. Bend metal contacts in for tighter fit.
3. Be sure RECEIVER and TRANSMITTER are within 20 to 25-foot operating range.
4. Keep RECEIVER from temperatures exceeding 120° F. Battery life shortened when ambient temperatures are above 115° F.
5. If RECEIVER is installed in tightly enclosed metal surround, the operating distance will be shortened.

NOTE:

1. Heat conditions can cause batteries to discharge when temperatures exceed 1150 F. Studies show that alkaline batteries, when exposed to a constant temperature of 1200 F, can lose up to 50% of their operating power. When the battery cools down, it will partially recharge itself, but constant heating and cooling will reduce the battery's normal life expectancy.

SPECIFICATIONS

BATTERIES: Transmitter 12V - (A23)

Remote Receiver 6V - 4 ea. AA 1.5 Alkaline

FCC ID No.'s: transmitter - K9LTMR2A; receiver - K9L330IRX

Operating Frequency: 303.8 MHZ

Canadian ISC ID No.'s: transmitter – 2439A-TMR2A; receiver – 2439A 3301RX

FCC REQUIREMENTS

NOTE: THE MANUFACTURER IS NOT RESPONSIBLE FOR ANY RADIO OR TV INTERFERENCE CAUSED BY UNAUTHORIZED MODIFICATIONS TO THIS EQUIPMENT. SUCH MODIFICATIONS COULD VOID THE USER'S AUTHORITY TO OPERATE THE EQUIPMENT.

FOR TECHNICAL SERVICE, CALL:

U. S. INQUIRIES

(855) 498-8324 or (260) 459-1703

CANADIAN INQUIRIES

(877) 472-3923

For Sales: (888) 672-8929

WEBSITE: skytechpg.com

MANUFACTURED EXCLUSIVELY FOR SKYTECH II, Inc