



**Model: FK-ESC (Fan Speed Control)**  
INSTALLATION AND OPERATION INSTRUCTIONS

IF YOU CANNOT READ OR UNDERSTAND THESE INSTALLATION INSTRUCTIONS  
DO NOT ATTEMPT TO INSTALL OR OPERATE

**INTRODUCTION**

The FK-ESC is designed as a retrofit speed control for use with an existing fan/blower.

Power must be provided through an approved factory installed junction box from the hearth product's manufacturer.

The FK-ESC (speed control) adjust the air output of the fan/blower. The speed control will turn ON the fan automatically 7 minutes after the main flame has been turned ON and turn the fan OFF 12 minutes after the main flame has been turn OFF. There are four speeds, Hi, Medium Hi, Medium Lo, Lo and OFF. You can manually adjust the speed by pressing the FAN SPEED button. The FK-ESC will remember the last setting used and remain on that setting until changed. See the OPERATION section for more details.

**CONTENTS:**

1. FK-ESC (speed control)
2. Jumper Wire (used for IPI valves only)
3. Jumper Wire (used to jump power strip when applicable)
4. ACF10 (10-inch cord with ground wire and receptabe)

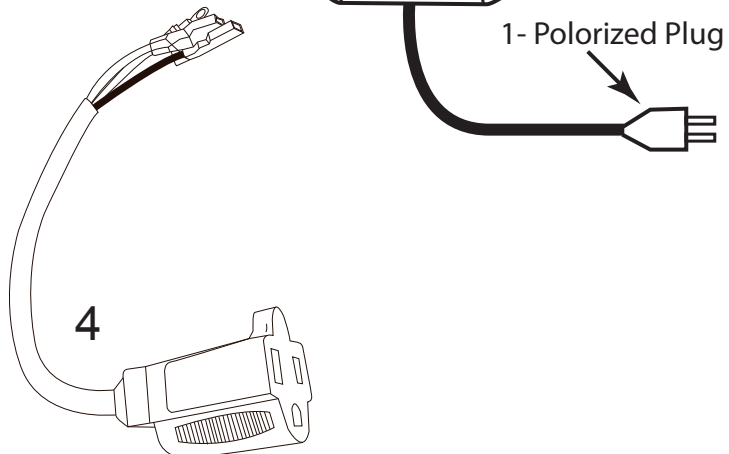
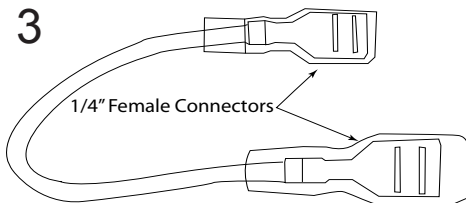
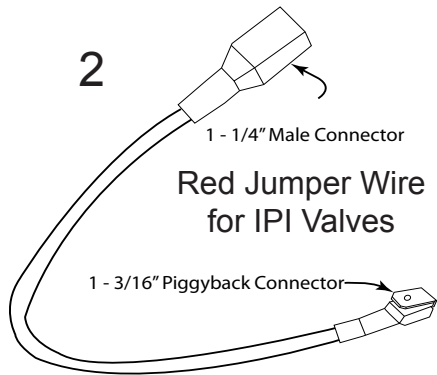
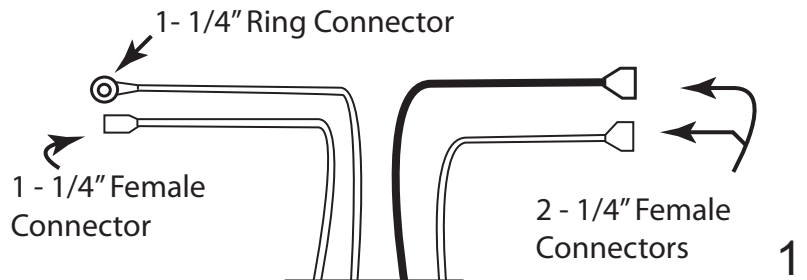

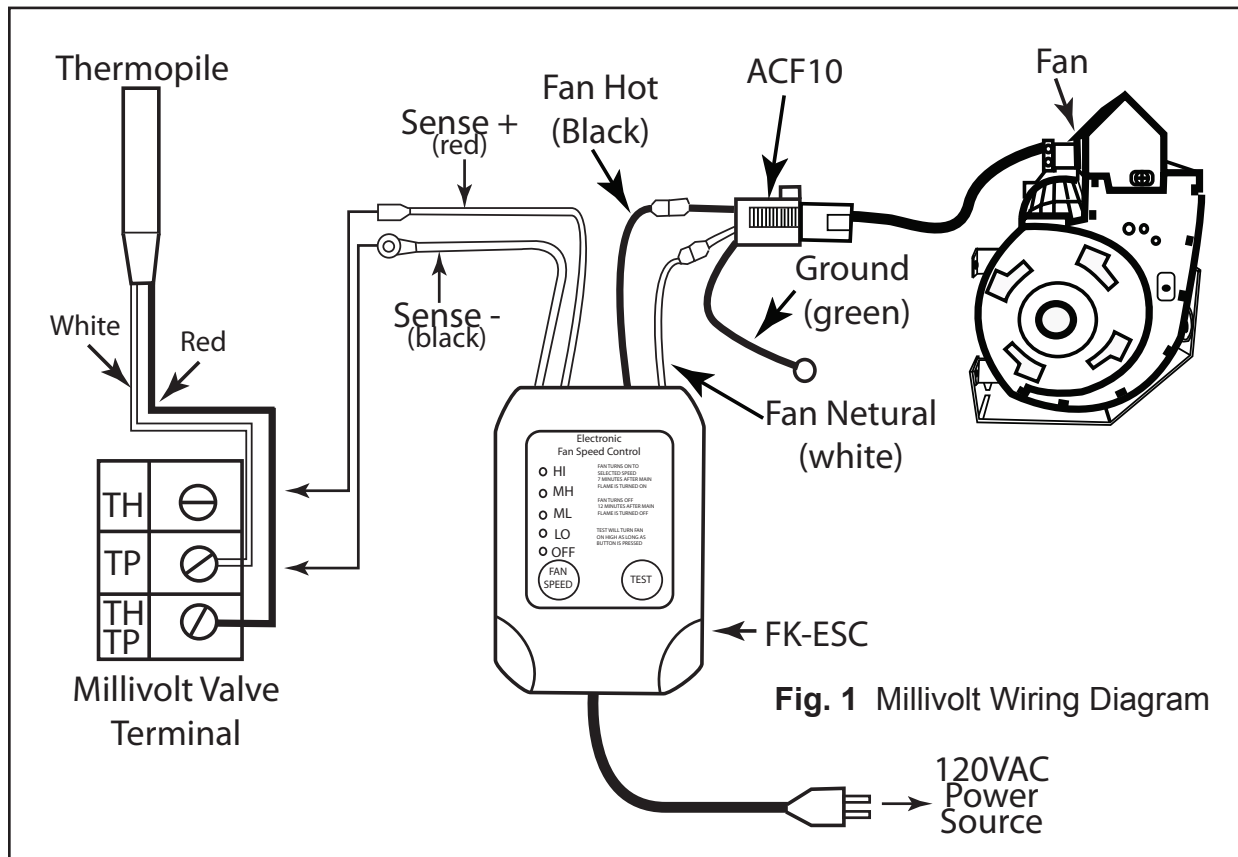

**WIRING NOTES:** *This is a polarity sensitive system. Ensure you wire it exactly as shown in the diagram above. Thermopile wires must also be located with Red at TH/TP and White at TP on the gas valve.*

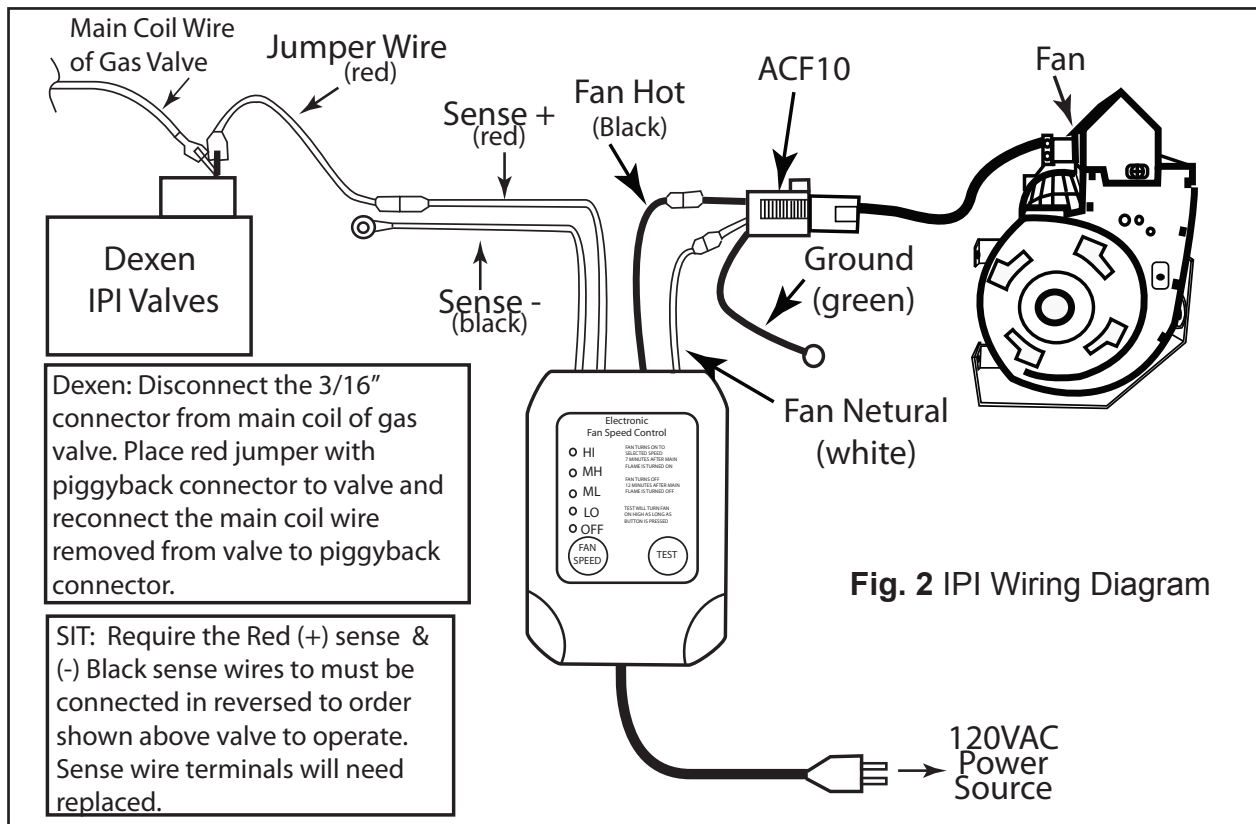

**WIRING NOTES:** *When wiring an IPI system the Sense - (black) wire must be secure to a ground on the gas valve or to metal on the appliance for proper operation.*

## **INSTALLATION NOTES:**

- Step 1:** Before installing the FK-ESC into the fireplace attach the ACF10 cord to the FAN HOT (Black) and the FAN NETURAL (White) wires matching colors as shown in diagrams.
- Step 2:** Unplug the existing fan from its power source and plug it into the ACF10 receptacle.
- Step 3:** Plug the FK-ESC into the power source the fan was previously plugged into.
- Step 4:** Make the necessary connections to the valve system as shown in the diagrams.
- Step 5:** Ensure to ground the green wire from the ACF10 before completing installation.

## **POWER SOURCE INFORMATION**

When plugging in the FK-ESC into a 120VAC power source, some fireplaces use a standard metal junction box and other fireplaces may use a power strip. If a power strip is used (as shown in drawing below) and no power is found in the FAN outlet use the red jumper wire with the 1/4" connectors and attach as shown below. With the jumper installed the FAN outlet will provide the power necessary to operate the FK-ESC system.

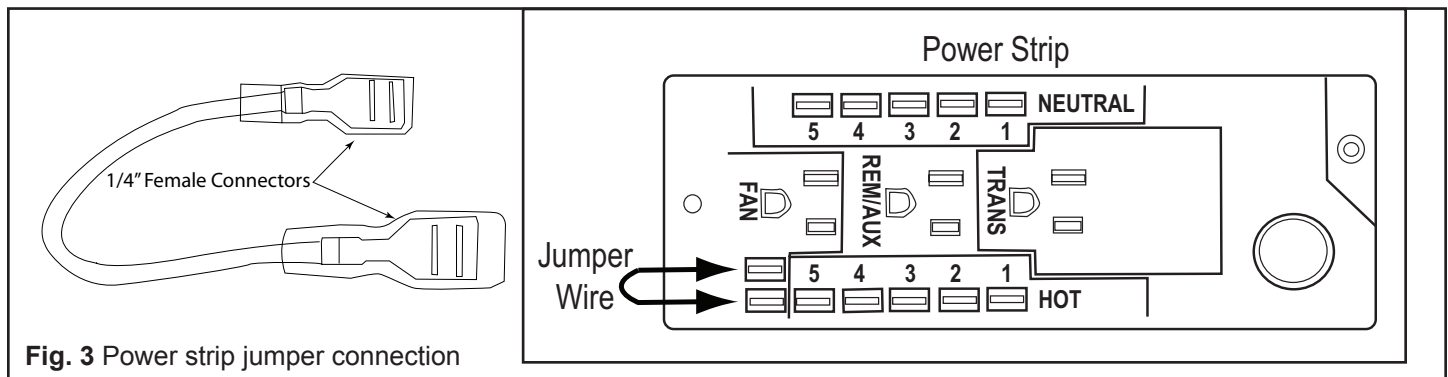

**Fig. 3** Power strip jumper connection

## **OPERATION**

To check the fan for proper wiring press the TEST button. This is a manual override that will operate the fan on HI as long as the button is depressed then it will return to normal operation after releasing the button.

The FK-ESC speed control will turn the fan ON automatically 7-minutes after the main flame has been turned ON and turn the fan OFF 12-minutes after the main flame has been turn OFF. There are four speeds, Hi, Medium Hi, Medium Lo, Lo and OFF. The factory default speed setting is HI upon initial use. You can manually adjust fan speed by pressing the FAN SPEED button; with each press of the button you can change the various fan speeds. The LED lights will allow you to visually see the fan speed you selected.

The FK-ESC will remember the last setting used however it will always turn ON to the HI setting for 5-seconds then return to the last setting.

## **TROUBLE SHOOTING**

### **FK-ESC Won't Turn ON in 7-Minutes**

1. Press the TEST button to ensure there is power to the fan.  
If no power is present, check the 120VAC outlet the FK-ESC is plugged into. Use a lamp or radio to ensure power is present. If no power is present, check circuit breaker or find another power source.
2. If using the power strip jumper wire shown in Fig. 3 ensure the jumper is installed properly allowing power to be supplied to the power strip.
3. The FK-ESC is designed to operate with a Millivolt or IPI system. The operational specification for the Sense voltage is 50mVDC to 9VDC. It will not operate with a 24VAC gas valve system.

### **FK-ESC Won't Turn OFF in 12-Minutes**

1. Ensure ALL wires are properly secured and placed on the correct terminals of the gas valve (Figs. 1 & 2) This is a polarity sensitive system; if wires are reversed it will not turn OFF the fan.

## **MAINTENANCE**

Cleaning on a semi-annual basis is required to keep the warranty in place. Dust or dirt must be removed from the fan blades, air inlets and blower outlet for the fan kit to maintain the efficiency of the system. Carefully use a vacuum with a brush to remove any dust. If unable to reach fan with a vacuum remove the fan from the appliance for easier cleaning.

## **TWO YEAR LIMITED WARRANTY**

SKYTECH II warrants this FK-ESC speed control is two years or 24 months from the date of purchase or installation to the original owner. This warranty is NOT transferable to another person. Should any part fail because of defective workmanship or material from the original date of purchase SKYTECH II will repair or replace the part at SKYTECH II option.

Damage to the FK-ESC caused by accident, misuse, abuse, or installation error, whether by a contractor, service company, or owner is not covered by this warranty. Modification of the Fan System will void the warranty.

The owner must provide a bill of sale, cancelled check or a payment record should be kept to verify purchase date and establish warranty period. SKYTECH II is not responsible for: Travel expenses, Diagnostic costs, and Service labor to repair the defective Fan system. Freight charges will not be covered on warranty parts or Fan systems.

This warranty does not cover claims, which do not involve defective workmanship or materials.

IN NO EVENT SHALL SKYTECH II BE LIABLE FOR INCIDENTAL AND CONSEQUENTIAL OCCURRENCES, INCLUDING THE IMPLIED WARRANTIES OR MERCHANTABILITY AND FITNESS, ARE LIMITED TO THE DURATION OF THE THIS WRITTEN WARRANTY. THIS WARRANTY SUPERSEDES ALL OTHER ORAL OR WRITTEN WARRANTIES.

Some states do not allow the exclusion or limitation of incidental and consequential damages or limitation on how long an implied warranty lasts, so the above limitation may not apply to you. This warranty gives you specific rights and you may have other rights, which vary from state, province, and nation.

Warranty claims process will start with all information; SKYTECH II will reserve the right to physically inspect the product for defects, by authorized representatives.

**FOR TECH SERVICE, CALL (855) 498-8324**

Skytech Products Group  
9230 Conservation Way  
Fort Wayne, IN 46809  
Sales Support: (888) 699-6167  
Canadian Inquires: (877) 472-3923

[www.skytechpg.com](http://www.skytechpg.com)

